



HINGES
FOR PVC





HINGE
FOR PVC
AXL / EXL



PVC HINGES AXL - 2 - WING

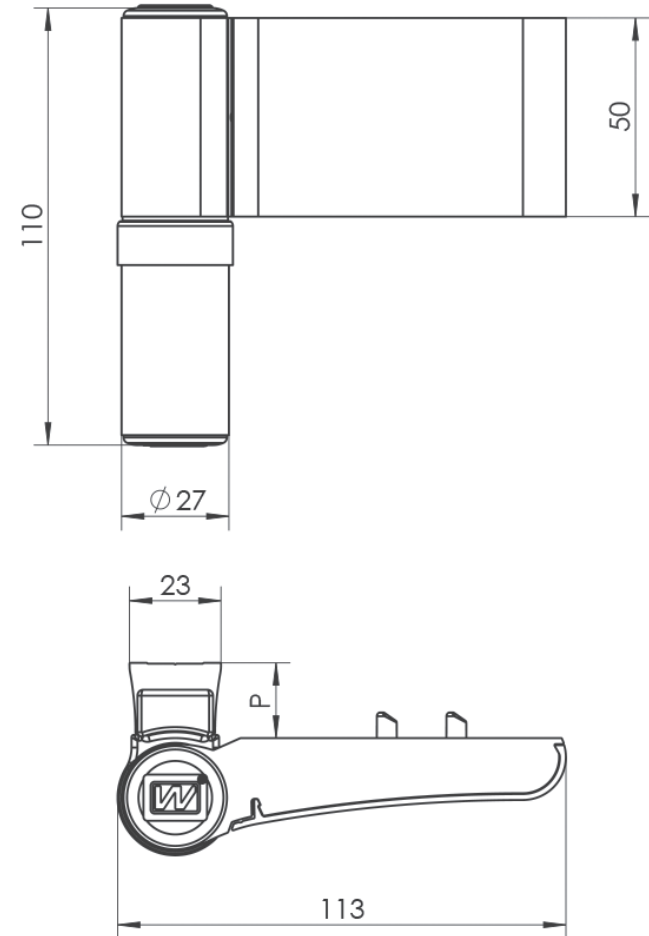

P – upstand in „0” position:
AXL 19... – 19mm (16 - 22 mm)
AXL 22... – 22mm (19 - 25 mm)
AXL 24... – 24mm (21 - 27 mm)

Due to the application the 3mm distance plate,
the upstand 20mm, 22mm and 24mm can be achieved.



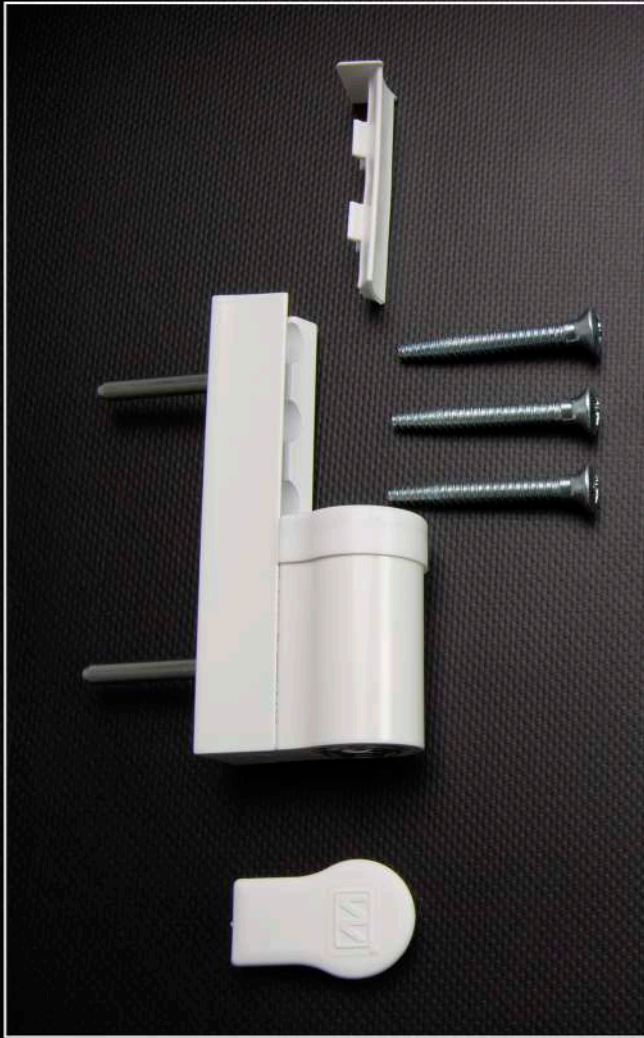

ASSEMBLY ELEMENTS
OF A DOOR FRAME



ASSEMBLY ELEMENTS
OF A DOOR SASH

PVC HINGES AXL - 3 - WING



-  C-35 BLACK ANODE F40
-  ANODE NATURAL
-  INOX COATING
-  GOLDEN ELECTROPOLER



P – upstand in „0” position:
 AXL 19... – 19mm (16 - 22 mm)
 AXL 22... – 22mm (19 - 25 mm)
 AXL 24... – 24mm (21 - 27 mm)

Due to the application the 3mm distance plate,
 the upstand 20mm, 22mm and 24mm can be achieved.

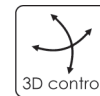
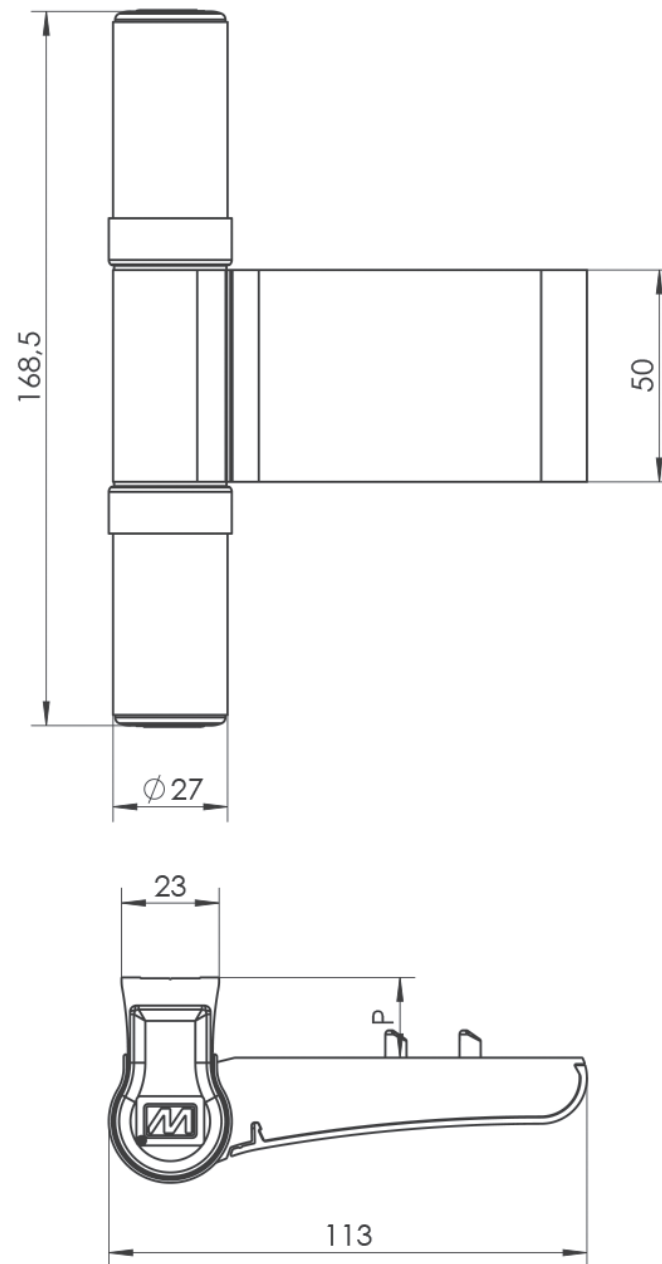



ASSEMBLY ELEMENTS
OF A DOOR FRAME

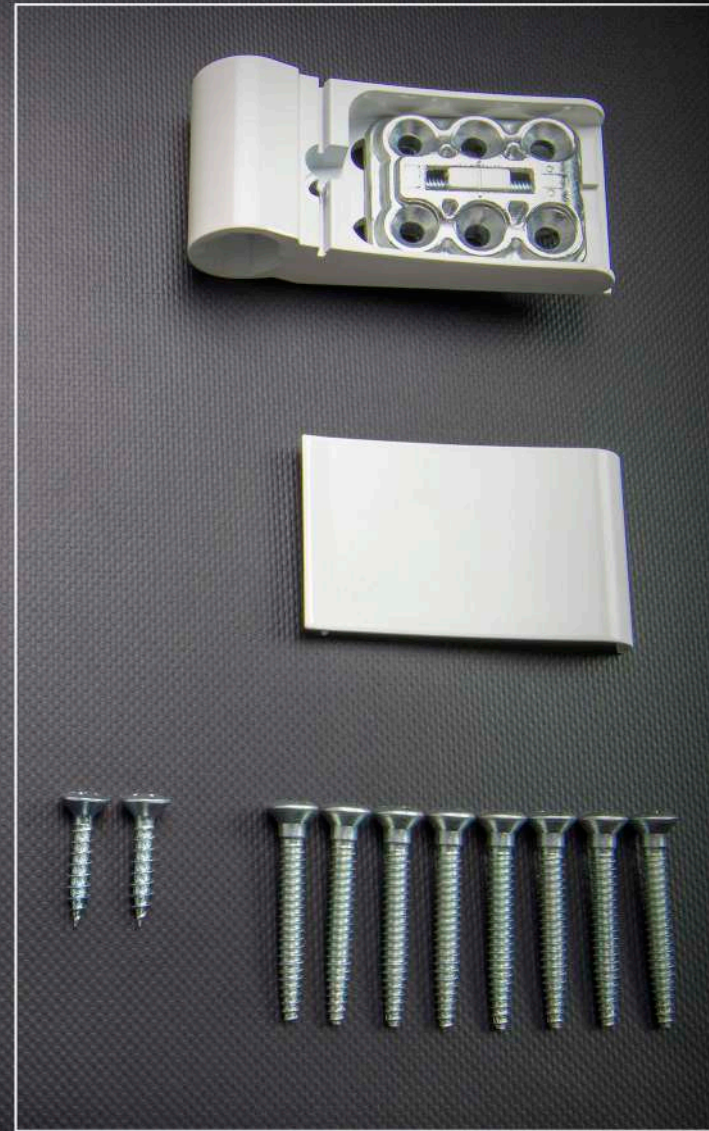

ASSEMBLY ELEMENTS
OF A DOOR SASH

PVC HINGES EXL - 2 - WING

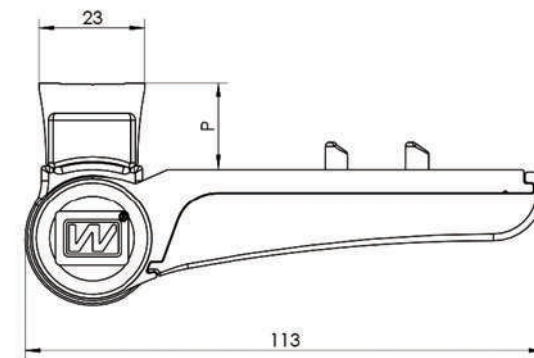
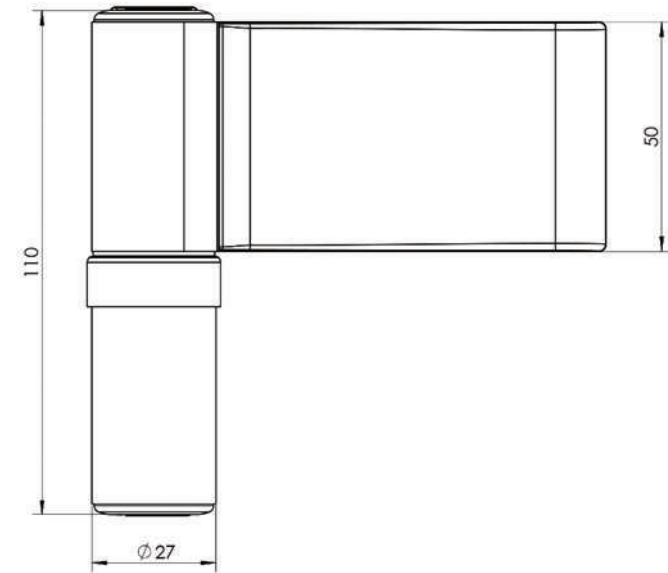

P – upstand in „0” position:
 EXL 19... – 19mm (16 - 22 mm)
 EXL 22... – 22mm (19 - 25 mm)
 EXL 24... – 24mm (21 - 27 mm)

Due to the application the 3mm distance plate,
 the upstand 20mm, 22mm and 24mm can be achieved.



PVC HINGES EXL - 3 - WING

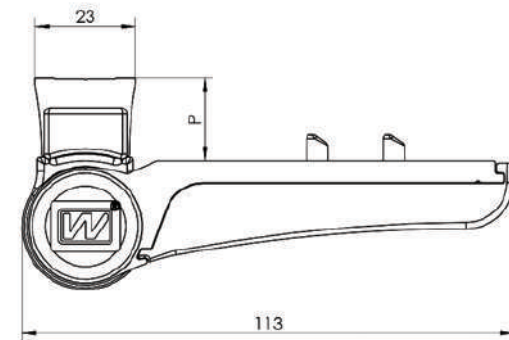
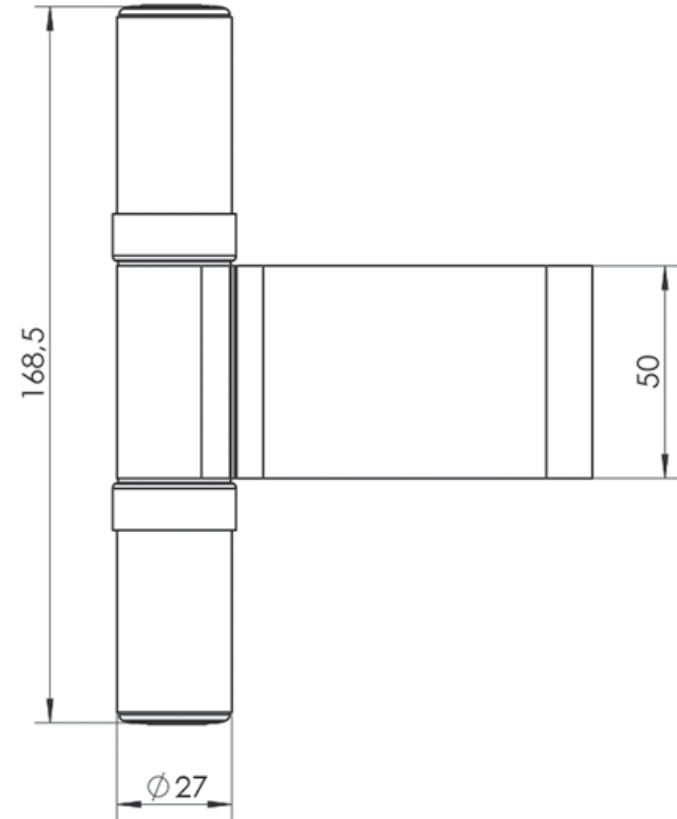

P – upstand in „0” position:
 EXL 19... – 19mm (16 - 22 mm)
 EXL 22... – 22mm (19 - 25 mm)
 EXL 24... – 24mm (21 - 27 mm)

Due to the application the 3mm distance plate,
 the upstand 20mm, 22mm and 24mm can be achieved.



PVC HINGES AXL / EXL

FOR USE IN EMERGENCY EXIT DOORS

**AXL / EXL HINGE CLASSIFICATION
EN 1935:2002 + EN 1935:2002/AC:2003**

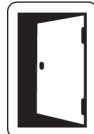

4/4 - SERVICE CLESSES



7/7 - DURABILITY

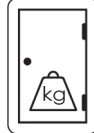

7/7 - WEIGHT OF TEST DOOR



0/1 - FIRE RESISTANCE



1/1 - SECURITY



4/4 - CORROSION RESISTANCE



1/1 - INTRUSION PROTECTION

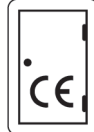

14/14 - HINGE CLASS



PVC HINGES AXL / EXL

2 - WINGS - TOOLING IN PROFILE

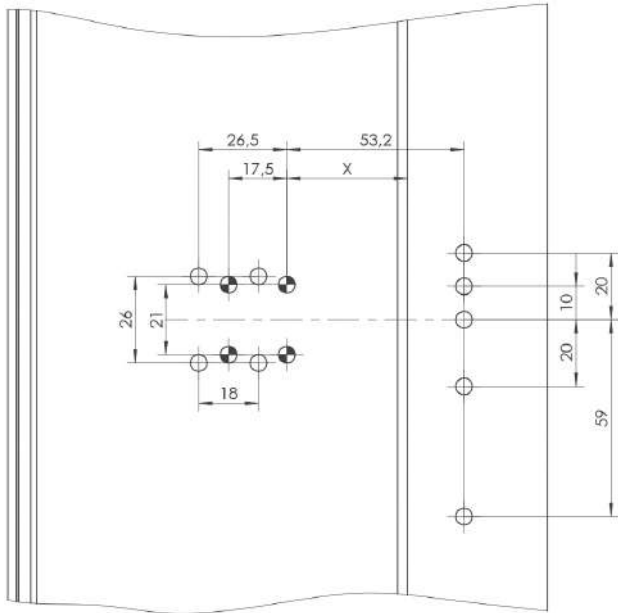



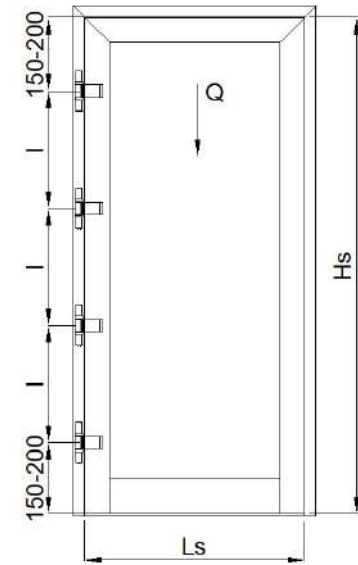
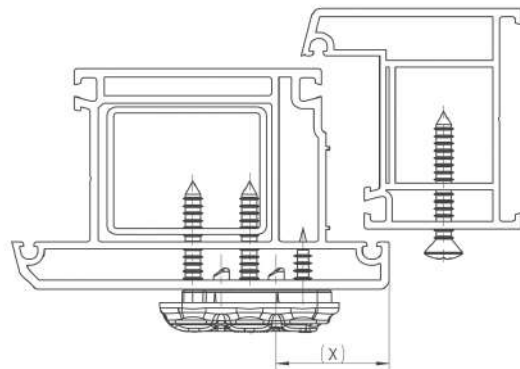
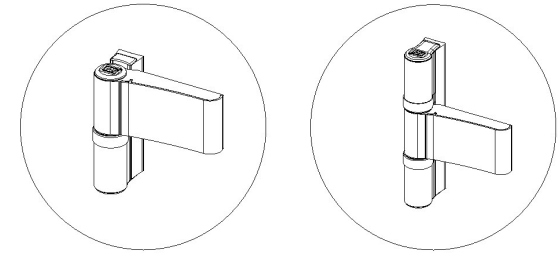
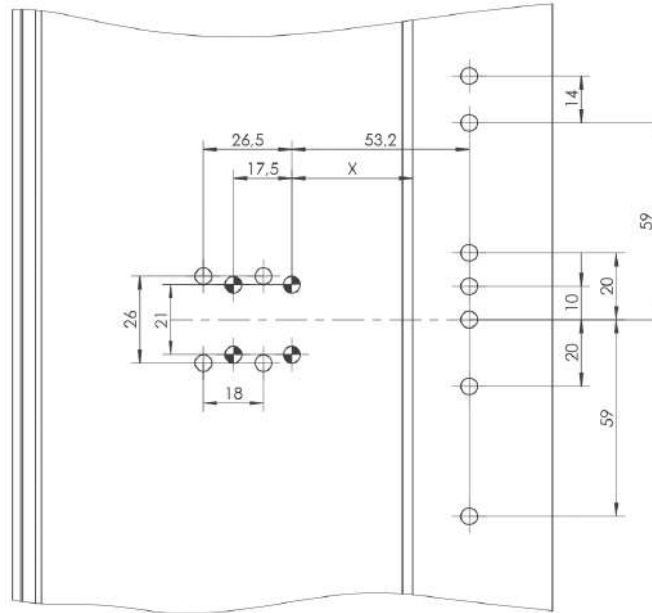



3 - WINGS - TOOLING IN PROFILE





LOAD SELECTION AXL / EXL

If the distance between hinges in the middle of a door exceeds 1500mm, we suggest using additional hinge which caulks the door.

 Private building
  Public building
  Door closer
  2-wing hinge
  3-wing hinge

	W	S								
			800	900	1000	1100	1200	1300	1400	
	2000	180	180	170	155	145	140	130	125	
	2100			175	165	150	145	135	130	
	2200			175	160	150	140	135		
	2300		180	180	170	160	150	140		
	2400				175	165	155	145		
	2500		180	180	180	170	160	150		
	2600					175	165	155		
	2700					175	165	165		
	2800		180	180	180	180	170	165	165	
	2900						175	170		
	3000						180	180		

	W	S									
			800	900	1000	1100	1200	1300	1400		
	2000	210	210	195	180	170	155	140	130		
	2100			200	190	175	160	150	135		
	2200			200	185	170	155	140			
	2300			210	210	195	180	165	150		
	2400					205	190	175	160		
	2500			210	210	210	200	185	170		
	2600						195	180			
	2700						205	190			
	2800			210	210	210	210	200	185	170	
	2900							105	190		
	3000							210	210		

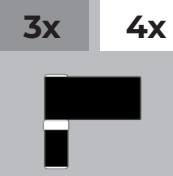

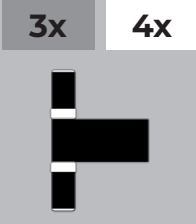

	W	S								
			800	900	1000	1100	1200	1300	1400	
	2000	140	140	130	115	105	110	100	95	
	2100			135	125	110	115	105	100	
	2200			140	135	120	120	110	105	
	2300		150	150	150	140	130	120	110	
	2400					145	135	125	115	
	2500		150	150	150	140	130	120		
	2600					145	135	125		
	2700					145	135	135		
	2800		150	150	150	150	140	135	135	
	2900						145	140		
	3000						150	150		



	W	S									
			800	900	1000	1100	1200	1300	1400		
	2000	170	170	155	140	130	125	110	100		
	2100			160	150	135	130	120	105		
	2200			170	160	145	140	125	110		
	2300			180	180	180	165	150	135	120	
	2400						175	160	145	130	
	2500			180	180	180	170	155	140		
	2600						165	150			
	2700						175	160			
	2800			180	180	180	180	165	150	140	
	2900							175	160		
	3000							180	180		







LOAD SELECTION AXL / EXL



If the distance between hinges in the middle of a door exceeds 1500mm, we suggest using additional hinge which caulks the door.

 Private building
  Public building
  Door closer
  2-wing hinge
  3-wing hinge

	W	S											
			800	900	1000	1100	1200	1300	1400				
 3x	2000	150		140	125	115	110	100	95				
	2100			145	135	120	115	105	100				
	2200			145	130	120	110	105	105				
	2300		140							130	120	110	
	2400		145	135	125	115							
	2500		140	130	120	110	105	105					
	2600								145	135	125	115	
	2700		145	135	125	115	105	100					
	2800								140	135	125	115	110
	2900												
	3000		150	135	125	115	110	105					

	W	S											
			800	900	1000	1100	1200	1300	1400				
 3x	2000	180		165	150	140	125	110	100				
	2100			170	160	145	130	120	105				
	2200			170	155	140	125	110	105				
	2300		165							150	135	120	
	2400		175	160	145	130							
	2500		170	155	140	125	110	105					
	2600								165	150	135	120	
	2700		175	160	145	130	120	110					
	2800								165	150	135	120	110
	2900												
	3000		180	160	145	130	120	110					

	W	S											
			800	900	1000	1100	1200	1300	1400				
 3x 4x	2000	130		120	105	95	90	80	75				
	2100			125	115	100	95	85	80				
	2200			130	125	110	100	90	85				
	2300		120	110	100	90	80	75					
	2400								125	115	105	95	
	2500		120	110	100	90	80	75					
	2600								125	115	105	95	
	2700		125	115	105	95	85	80					
	2800								120	110	100	90	85
	2900												
	3000		130	115	105	95	85	80					

	W	S											
			800	900	1000	1100	1200	1300	1400				
 3x 4x	2000	160		145	130	120	105	90	80				
	2100			150	140	125	110	100	85				
	2200			160	150	135	120	105	90				
	2300		145	130	115	100	90	85					
	2400								155	140	125	110	
	2500		150	135	120	105	90	85					
	2600								160	145	130	115	
	2700		155	140	125	110	100	90					
	2800								145	130	115	100	90
	2900												
	3000		160	140	125	110	100	90					



ADJUSTMENT FOR HINGES AXL / EXL

Sealing pressure
adjustment (upstand)
 $\pm 3,5$ mm

Height
adjustment
+ 5 mm
- 2 mm

Left / right
adjustment
 $\pm 5,5$ mm

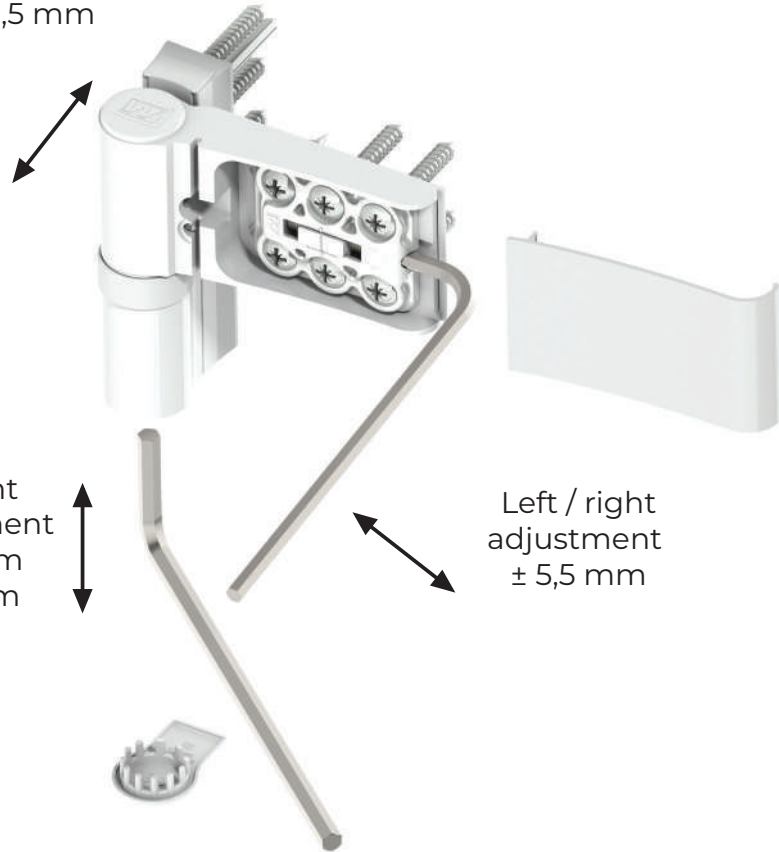

Sealing pressure
adjustment (upstand)
 $\pm 3,5$ mm

Height
adjustment
+ 5 mm
- 2 mm

Left / right
adjustment
 $\pm 5,5$ mm

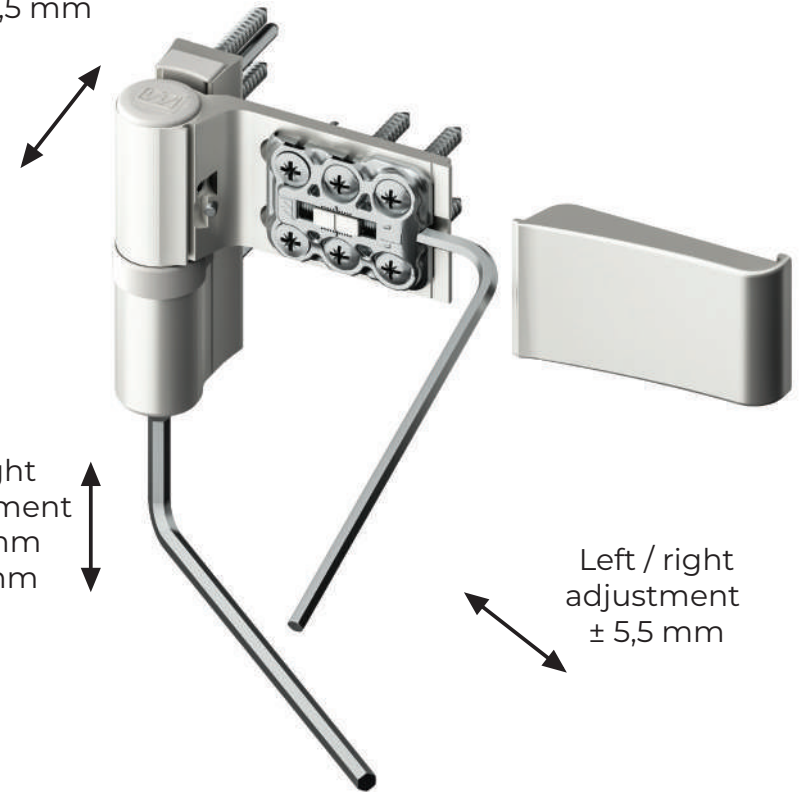

PATTERNS FOR DRILLING AXL / EXL

AXL / EXL



AXL / EXL

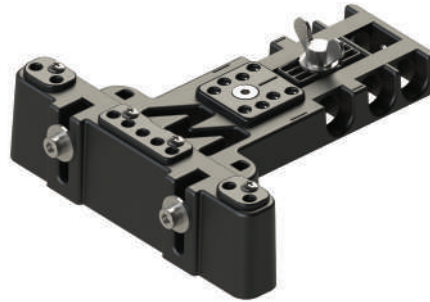

TRIPLE TEMPLATE



DISTANCE THICKNESS A	VALUE X
2 mm	40 mm
4 mm	38 mm
6 mm	36 mm
8 mm	34 mm



DISTANCE THICKNESS A	VALUE X
4 mm	36 mm
5 mm	35 mm
6 mm	34 mm
7 mm	33 mm
8 mm	32 mm







WALA Sp. z o.o.
ul. Parkowa 16
43-365 Wilkowice

wala@wala.pl
tel. +48 33 82 72 390
kom. +48 725 70 80 30
www.wala.pl

